









# Wood And Metal Swivel Stool

Model #104823-131135 (4803-827C) Counter Stool

Model #104823-131136 (4803-831C) Barstool

Examine all packaging material for small parts that may have come loose during shipment. Periodic checks are recommended to insure that all components are in proper position, tight and free from damage. Keep this assembly instruction for future reference. Adult assembly is required. The product is designed for residential use only. Customer Service Phone Number: 502-562-0000

CODE	QTY	HARDWARE	
1	8	1/4" x 35mm Allen Bolts	
2	8	Φ6.5 Spring Washers	
3	4	Φ6.5 x δ1.5 x φ13 Flat Washers	
4	4	Φ6.5 x δ1.5 x φ16 Flat Washers	
5	1	Allen Wrench	

CODE	QTY	COMPONENTS	CODE	QTY	COMPONENTS
A	1	Top 	B	1	Bottom 
			C	1	Cushion 

## WARNING

- Do not let any sharp objects touch or rub the surface of the product.
- When assembling, do not let children play around the working area.
- Please confirm all parts are correct before starting the assembly process.
- Do not tighten all bolts and screws completely until the entire unit has been assembled and set up.
- Be careful if using power tools as they can over tighten screws and strip threads.

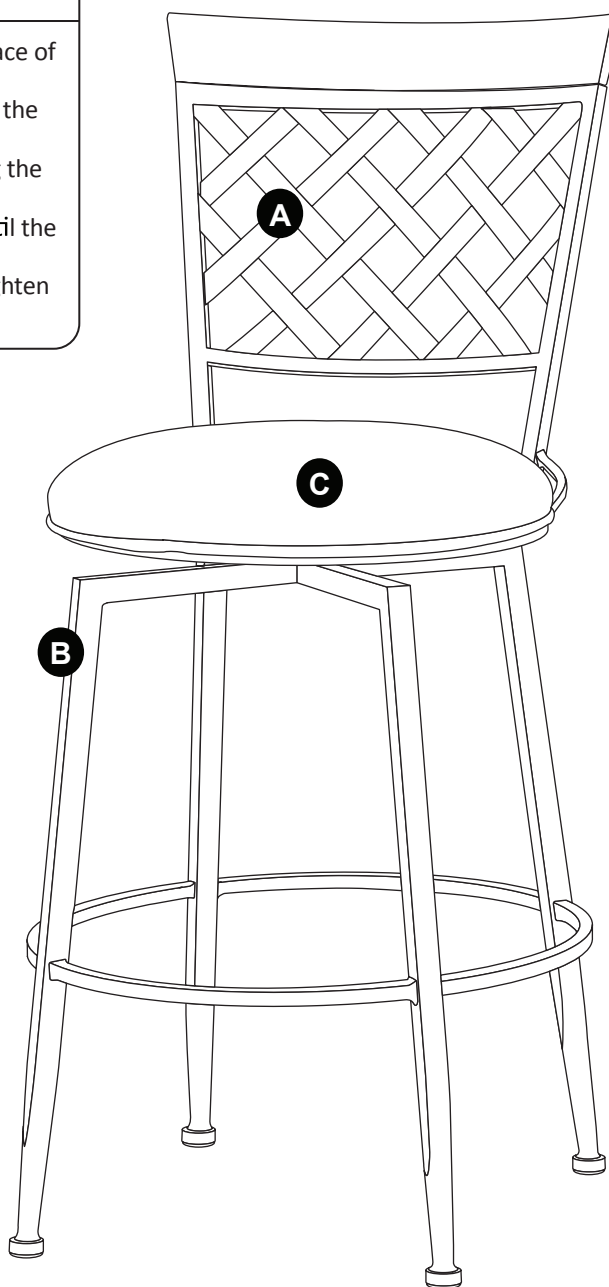

# Wood And Metal Swivel Stool

Model #104823-131135 (4803-827C) Counter Stool

Model #104823-131136 (4803-831C) Barstool

Date: 11-08-2018

Page 2 of 2

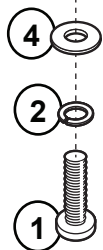
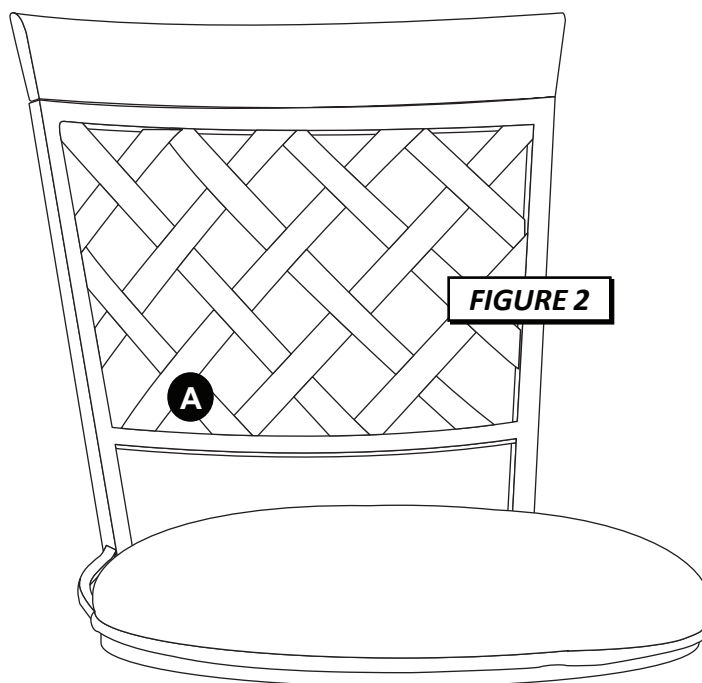
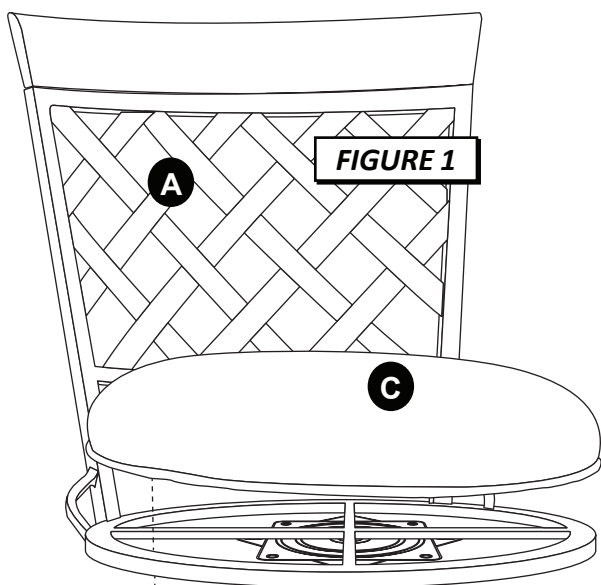

## STEP 1 - Figure 1

Begin assembly by attaching Cushion using 4 Allen Bolts (1), 4 Spring Washers (2), and 4 Flat Washers (4).

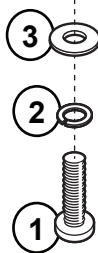

## STEP 2 - Figure 2

Attach Top (A) to Bottom (B) using 4 Allen Bolts (1), 4 Spring Washers (2), and 4 Flat Washers (3). Tighten all bolts using Allen Wrench (5) provided. The assembly is now complete.

